



Base Plus



Installation
manual

SUMMARY

1	Introduction	4
1.1	▪ Symbols used in the manual	4
1.2	▪ Personnel requirements	4
1.3	▪ Required equipment	4
1.4	▪ Contents of packaging	5
2	Safety	5
2.1	▪ General safety information	5
2.2	▪ Requirements for working in safety	5
2.3	▪ Working environment.....	5
3	Technical tables for installation	6
3.1	▪ Table of loads on awning fastening plugs, based on type of attachment	6
3.2	▪ Table of suggested anchoring devices	7
3.2.1	▪ Types of anchoring devices based on base material.....	7
3.2.2	▪ Sequence for fastening of anchoring devices.....	8
3.3	▪ Diagrams of covering	9
3.4	▪ Box support brackets.....	10
4	Installation of manual awning	11
4.1	▪ Fastening brackets to wall	11
4.2	▪ Installation of box.....	13
4.3	▪ Adjustment of awning inclination	13
5	Installation of motorized awning	14
5.1	▪ Limit switch calibration	14
5.2	▪ Electrical connections and installation.....	15
6	Optionals	15
6.1	▪ Automations	15
7	Special maintenance	16
7.1	▪ Troubleshooting table	16

1 INTRODUCTION

This manual for the **Base Plus** awning was prepared by the manufacturer to provide necessary information to those authorized to install and perform special maintenance of the product.

It is prohibited to remove, rewrite or in any way modify the pages of the manual and their content.

Operations must be carried out by personnel with the technical and professional skills required by current applicable national laws or standards.

This manual must be kept complete in all its parts in an easily accessible place.

The manufacturer reserves the right to update products and corresponding manuals without the obligation to update previous manuals.

The manufacturer reserves all rights on this manual. It may not be reproduced in any way, wholly or in part, without the manufacturer's written authorization.

1.1 Symbols used in the manual

The WARNING symbols used in the manual are shown below.

INFORMATION AND PRECAUTIONS

Useful advice and instructions to be observed to ensure proper installation and/or maintenance of the awning. Failure to observe these messages may compromise the integrity and/or the resistance of the product.

ATTENTION

DANGER TO OPERATOR! Instructions to be evaluated and followed carefully. Failure to comply with these messages may compromise individual safety.

1.2 Personnel requirements

Personnel assigned to this operation must have technical knowledge of the product obtained either through two years' experience or by means of a suitable technical training course.

1.3 Required equipment

To ensure proper installation of the awning, and consequently best operation of the finished product, the following equipment is required:

- power screwdriver;
- a level;
- string;
- complete tool set;
- equipment for working at heights (scaffolding, ladders, aerial platforms, etc.) which are compliant with current standards of individual safety in the workplace.

ATTENTION

All of the screws used on aluminium components must be tightened with a maximum force of 20Nm (=2Kgm). Greater tightening force causes the breakage of fusions and damage to the stainless steel screws. It is advisable to use dynamometric power screwdrivers and wrenches.

ATTENTION

Use low-speed power screwdrivers. Screwing in the stainless steel screws at high speed may cause the threads to jam, especially in the case of stainless steel/stainless steel and stainless steel/ aluminium screws and threads.

ATTENTION

In the square bar supports with double screw, be sure to evenly screw the two fastening screws of the square bar, distributing the tightening force alternatively on the two screws up to a maximum of 20Nm. Uneven tightening may cause abnormal tension in the fusion, causing it to fail immediately, or lead to subsequent problems caused by external stress on the awning (e.g. gusts of wind).

1.4· Contents of packaging

The awning is delivered complete with extensible arms, fabric, control (manual or motorized) and any requested optional.

INFORMATION AND PRECAUTIONS

Never move the arm supports from the position in which they are supplied.

2 SAFETY

2.1· General safety information

- During all operations described in this manual, make sure that **ONLY** individuals involved in the work are in the work zone (see Chap. 1.2 “Personnel requirements”).
- Do not set objects on the canvas of the awning.
- It is prohibited to stand on or hang from the awning. This would create the risk of severe personal injury, as well as damaging the awning.
- Wear individual safety gear and clothing as required by current standards on workplace safety.



ATTENTION

Installation, adjustment, and special maintenance of the awning must be carried out only by specialized, skilled technical personnel.



ATTENTION

It is necessary to ensure a distance of at least 500 mm between the end of the fully-opened awning (outermost part) and any fixed obstacle (wall, terrace, etc.).



ATTENTION

It is prohibited to install or place ladders or other objects near the awning, as this would reduce the space required for installation.

2.2· Requirements for working in safety

- Installation must be performed in full compliance with standards set forth by Presidential Decree 164/56 and Legislative Decree 494/96 for all that which concerns individual safety.
- Before use, check that all temporary structures (scaffolding, ladders, etc.) and all individual safety gear (harnesses, belts, etc.) are compliant with standards and in good condition.
- Always use suitable individual protection gear.
- If there is more than one installation technician, their work must be coordinated.
- Operators must work in compliance with the safety instructions given to them.
- If the awning is to be installed above ground level, the area underneath the awning must be marked off and guarded so that no one can get underneath the hanging load.
- Firmly tie the ropes or straps around the arm supports so that it does not slip and risk falling.

2.3· Working environment

- Installation and special maintenance must be carried out in a place that is sufficiently illuminated (based on specific standards) by either natural or artificial lighting. The operator must have a clear view of the work to be performed, and he must also prevent third persons from approaching the work area around the awning.

3 TECHNICAL TABLES FOR INSTALLATION

3.1 Table of loads on awning fastening plugs, based on type of attachment

i INFORMATION AND PRECAUTIONS

The calculations of the plugs were made taking into account the class of wind resistance of the awning as per standard EN 13561.

Wind resistance class 2

WALL INSTALLATION								
Extraction load on anchoring devices (KN)		WIDTH (m)						
		2.5	3	3.5	4	4.5	5	5.5
PROTUBERANCE (m)	1,35	0.90	1.04	1.18	1.33	1.47	1.61	1,75
	1,6	1.26	1.45	1.64	1.84	2.03	2.22	2,42
	1.85	1.63	1.88	2.14	2.39	2.64	2.90	3,15
	2,1	-	2.42	2.74	3.06	3.38	3.71	4,03
	2,35	-	2.98	3.38	3.77	4.17	4.57	4,97
	2,6	-	-	4.05	4.54	5.02	5.50	5,98
	2.85	-	-	4.81	5.39	5.96	6.54	7,11
	3.1	-	-	5.69	6.36	7.04	7.71	8,33

CEILING INSTALLATION								
Extraction load on anchoring devices (KN)		WIDTH (m)						
		2.5	3	3.5	4	4.5	5	5.5
PROTUBERANCE (m)	1,35	0.94	1.09	1.24	1,39	1.54	1.69	1,83
	1,6	1.30	1.50	1.71	1.91	2.11	2.31	2,51
	1.85	1.68	1.95	2.21	2.47	2.73	2.99	3,26
	2,1	-	2.49	2.82	3.15	3.48	3.81	4,14
	2,35	-	3.05	3.46	3.87	4.28	4.69	5,10
	2,6	-	-	4.15	4.64	5.13	5.63	6,12
	2.85	-	-	4.91	5.50	6.09	6.67	7,26
	3,1	-	-	5.80	6.48	7.17	7.86	8,49

The value in the table is in KN and expresses the extraction load of the plug that is under the greatest stress. These values are required for the selection of the most suitable anchoring, based on the type of material upon which the awning will be installed. Choose the anchoring by referring to the recommended load values in the Hilti General Catalogue.

Example: awning with ceiling attachment

- awning dimensions: 4x2.6 - load on plug: 8.09 KN - base material: non-cracked concrete C25.







Suggested plug: Hilti HST M10 or HST M12 (see technical characteristics of plugs in Hilti General Catalogue).

! ATTENTION

The selection of the most suitable fastening element depends on the type of base material and on its physical state. It is the responsibility of the installer to check the state of the base material before installing the awning. The installer is not obliged to use Hilti anchoring devices.

3.2. Table of suggested anchoring devices













3.2.1 Types of anchoring devices based on base material

Extraction load on anchoring devices (KN)	
<p>Hilti HST</p> 	<p>CONCRETE CRACKED CONCRETE HARD NATURAL STONE</p>
<p>Hilti HSA</p> 	<p>CONCRETE HARD NATURAL STONE</p>
<p>Hilti HIT-HY 150 with HAS</p> 	<p>CONCRETE</p>
<p>Hilti HIT-RE 500 with HAS</p> 	<p>CONCRETE HARD NATURAL STONE SOLID BRICK WOOD</p>
<p>Hilti HIT-HY 50</p> 	<p>BETON GAS SOLID BRICK WOOD</p>
<p>Hilti HIT-HY 20</p> 	<p>PERFORATED BRICK</p>

i INFORMATION AND PRECAUTIONS

For corrosive environments, we suggest using anchoring devices in stainless steel. For additional information, contact Hilti Italia S.p.A. technical service (e-mail: tecnici@hilti.com).

3.2.2 - Sequence for fastening of anchoring devices

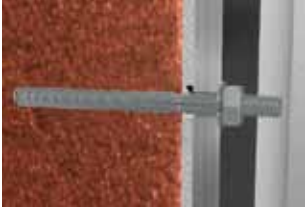
MECHANICAL ANCHORING DEVICE		CHEMICAL ANCHORING DEVICE	
	1° Make a hole with a drill bit that is suitable for the anchoring device		1° Make a hole with a drill bit that is suitable for the anchoring device
	2° Pay attention to how deep you make the hole		2° Pay attention to how deep you make the hole
	3° Remove dust and debris from the hole (preferably using compressed air)		3° Remove dust and debris using a brush
	4° Install the anchoring device		4° Remove residual dust with compressed air
	5° Tighten until achieving recommended tightening torque (see Hilti General Catalogue)		5° Inject the chemical adhesive
	6° Final configuration		6° Insert and settle the anchoring device. Comply with the setting time required before placing the plate (see product cartridge)
			7° After the time "T cure" has elapsed, place the plate and tighten until achieving recommended tightening torque (see Hilti General Catalogue)

! ATTENTION

For proper installation of the anchoring devices, refer to the Hilti General Catalogue.

3.3- Diagrams of covering

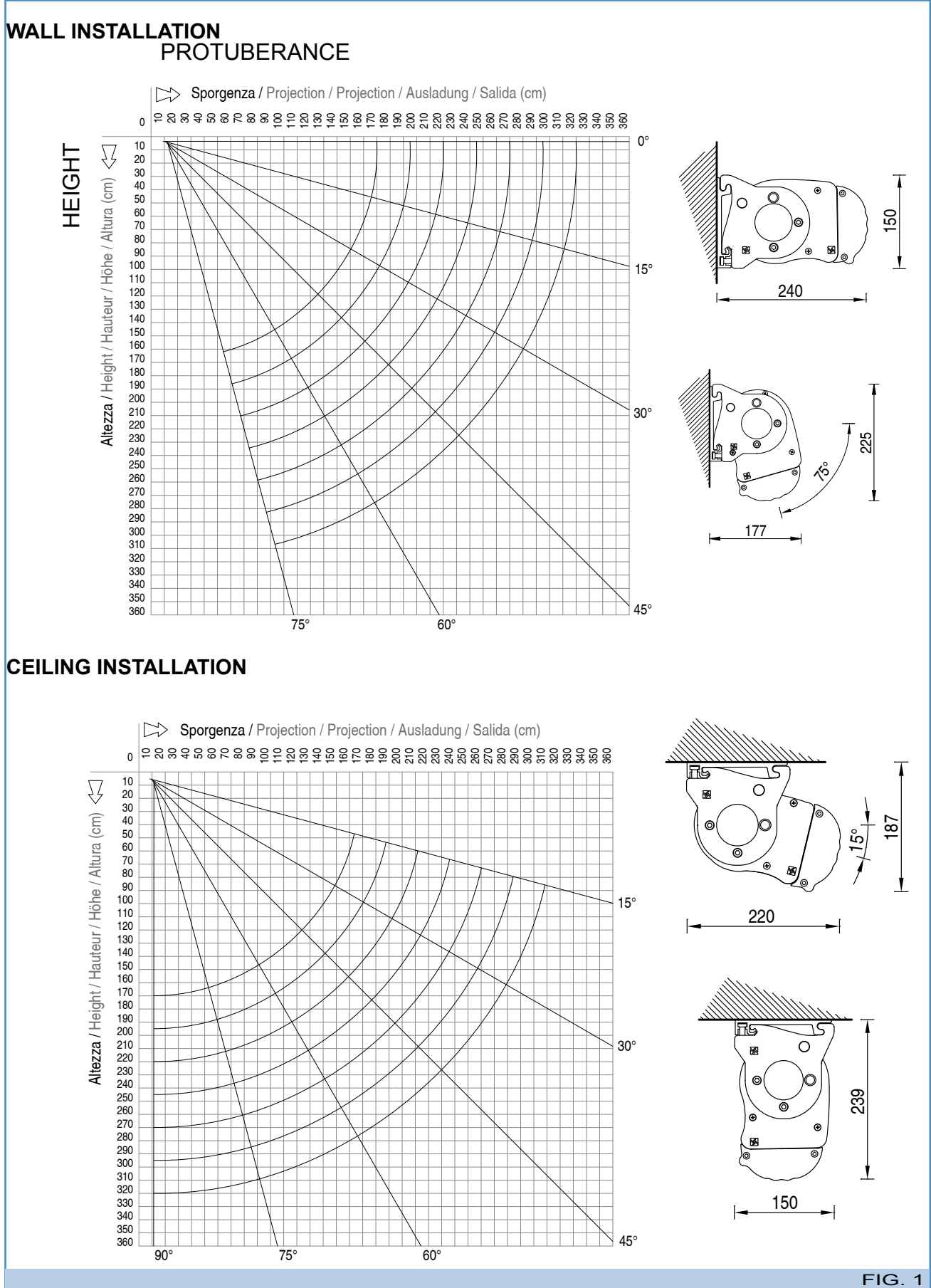

3.4· Box support brackets

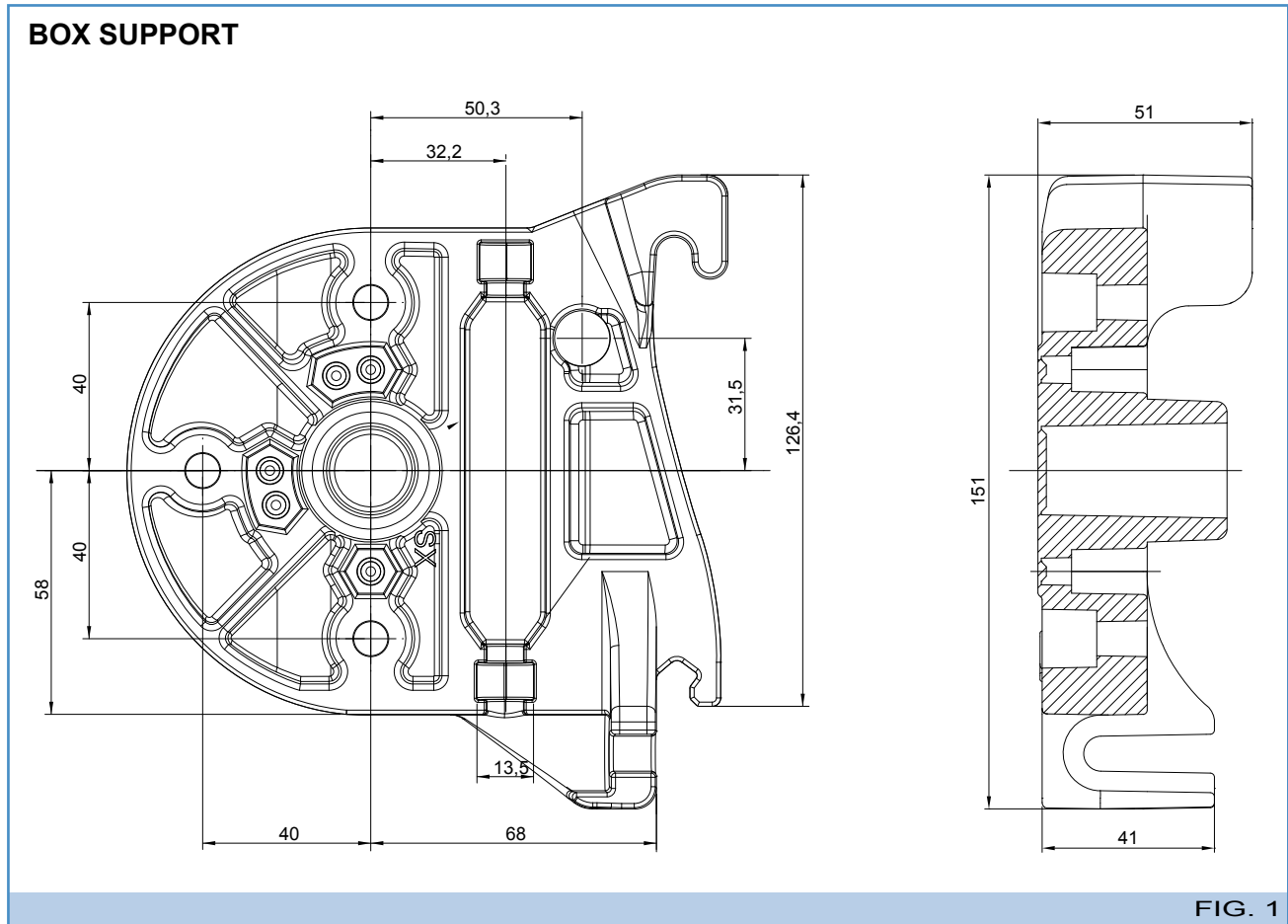

FIG. 1

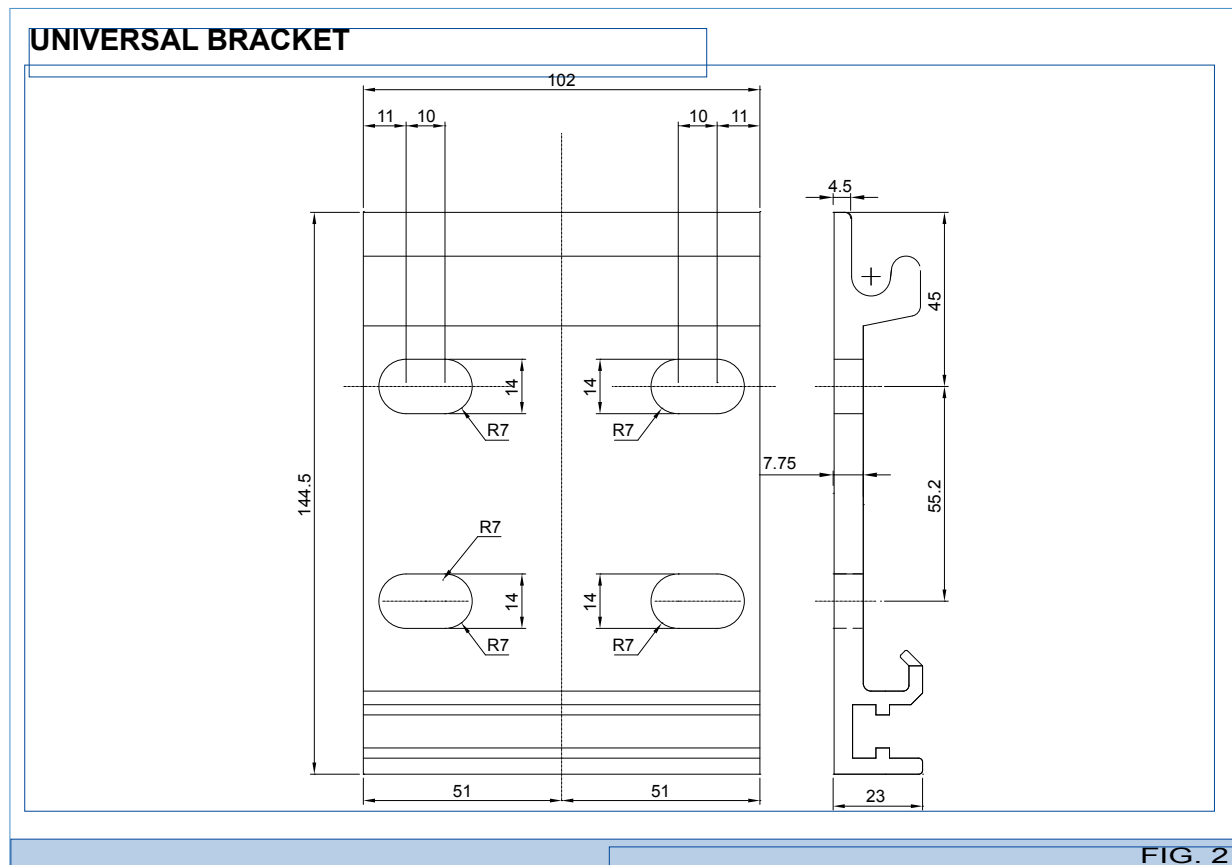

FIG. 2

4 INSTALLATION OF MANUAL AWNING

The **Base Plus** awning can be either wall-mounted or ceiling-mounted. The instructions below refer to **wall-mounting**; ceiling mounting is the same. If any optional are provided, **first read** chapter chapter 6 on optionals

ATTENTION

Ensure a minimum space of 500 mm between the open awning and any fixed obstacle. The awning must be installed at a minimum height of 2500 mm. If this is not possible, for awnings equipped with automations it is obligatory to install an acoustic warning device.

INFORMATION AND PRECAUTIONS

Use the most suitable plugs for the type of wall where the awning is to be installed.

INFORMATION AND PRECAUTIONS

For CEILING INSTALLATION, DO NOT FASTEN THE BRACKETS TO THE BLOCKS. The awning may fall with the risk of serious injury to individuals and damage to the product.

INFORMATION AND PRECAUTIONS

The procedure described below refers to the model of awning with two extensible arms. The operator must take the necessary measures for the installation of models with more than two arms (see table Chap. 3.1).

4.1 - Fastening brackets to wall

- 1- Before starting installation, take note of the following information, which is indispensable to find the right position for fastening the brackets:
 - dimensions of the awning (height and width of box, protuberance of awning when opened or closed);
 - dimensions of universal brackets (see Chap. 3.4 Fig.2);
 - side of awning where control is located;
 - dimensions of the wall/ceiling where the awning is to be installed.
- 2- Using a string and a level, mark on the wall the position of the holes to be made (see figure 2 page12).
- 3- The position of the holes is as shown in figure 1. For the right bracket use the holes (A), for the left bracket use the holes (B).
- 4- Always use three slots to fasten the brackets. If this is not possible, use two of them, diametrically opposite. (One slot remains free because it is covered by the box support).

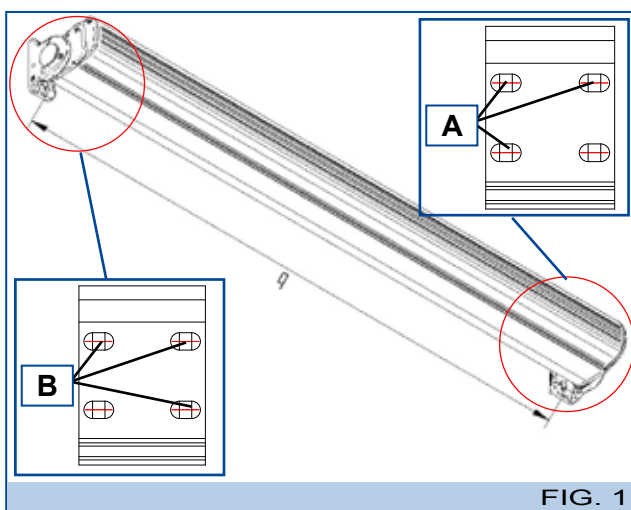

FIG. 1

i INFORMATION AND PRECAUTIONS

To make installation easier, you can print this page in A4 format and use it as a template to find the best position for the holes.

! ATTENTION

TO AVOID ERRORS, MAKE SURE THE PRINTOUT SCALE IS IN SCALE 1:1, CHECKING THE MEASURE INDICATED ON THE PAPER WITH A RULER OR CALLIPER (BRACKET WIDTH 102 MM)

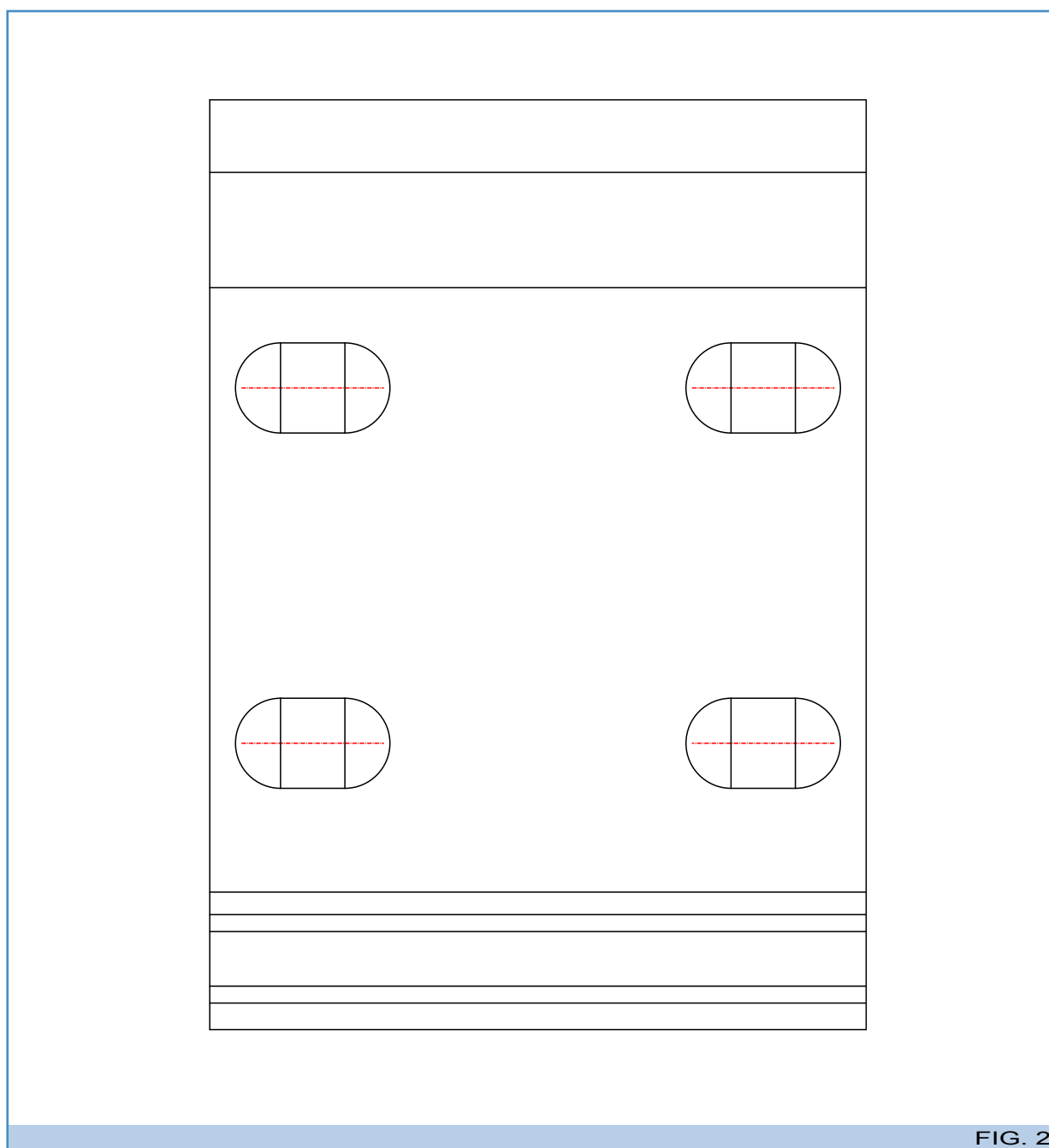

FIG. 2



FIG. 3

5° Drill a hole in the wall based on the type of screws available and the type of masonry in the correct position.

4.2 - Installation of box



FIG. 1

1° Fasten the brackets to the wall. Make sure that the inserts fasten to the slots on the bracket. Fasten the awning to the brackets (this lets you temporarily keep the awning fastened and lets you tighten the screws (A) safely.

2° Move the box so that it is flush with the end of the brackets and fasten the awning with the two screws (A).

i INFORMATION AND PRECAUTIONS

If the wall is off-square, it may difficult to install the box on the support brackets. It is therefore advisable to check the alignment of the brackets and to provide inserts to ensure proper alignment for good installation. Use a string to check alignment.

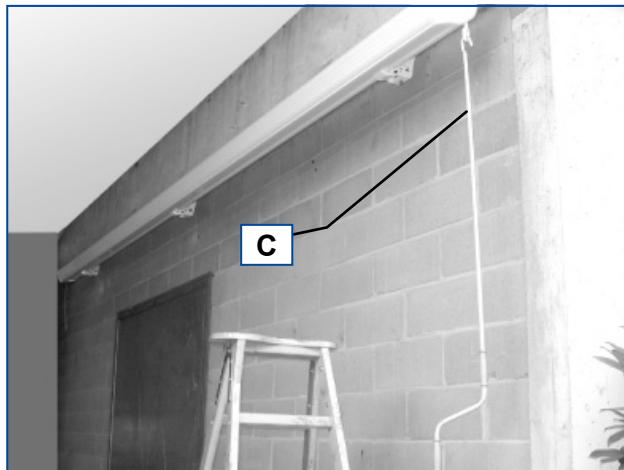

FIG. 2

3° Fasten the manoeuvre rod (C) to the winch.

4.3 - Adjustment of awning inclination

For this procedure, one worker will need to work on the brackets, and the other, **ONLY AFTER OPENING THE AWNING**, will guide the terminal so as to raise or lower the awning easily.

! ATTENTION

Make sure that when opening/closing the awning, there are no individuals within its range of action who are not involved in the work.

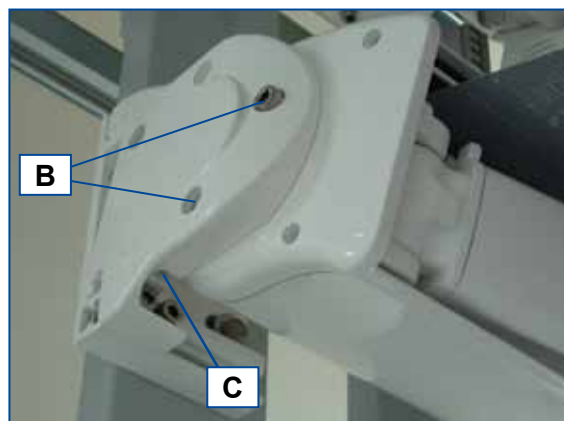

FIG. 1

1° With the awning open, loosen the two side screws (B) of the first support that you want to adjust, and adjust the inclination of the lever using the cylindrical head screw (C).

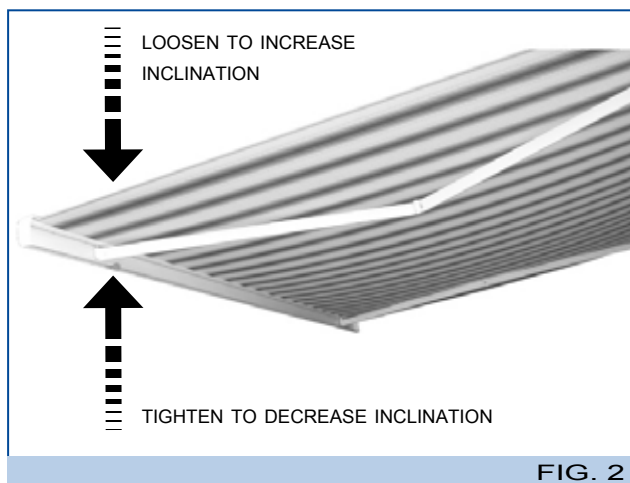

FIG. 2

- 2° Tighten the screw (C) to raise the awning on the side that corresponds to the support being adjusted.
- 3° Secure the two side screws (B).
- 4° Repeat the same steps on the other end of the awning.



FIG. 3

- 5° Using a level, check that the terminal is horizontal. Otherwise, adjust the box support that corresponds to the arm that is not level using the procedure indicated above.

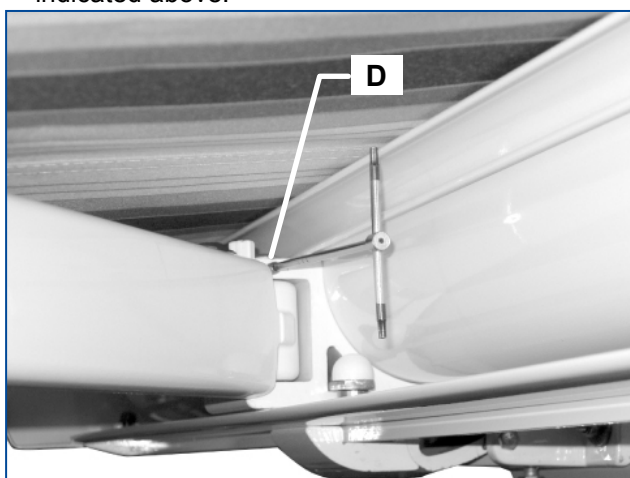

FIG. 4

- 6° Check that the elbows of the extensible arms are parallel. If necessary, turn the grub screw (D) to raise the elbow of the arm; unscrew it to lower it.

5 INSTALLATION OF MOTORIZED AWNING

! ATTENTION

IT IS PROHIBITED to install the motorized product in an explosive atmosphere.

! ATTENTION

Use a locking switch (with key) if the awning is installed in sensitive locations such as schools, boarding schools, hospitals, retirement homes, etc.

If the awning is equipped with a radio remote control, keep it out of the reach of children.

! ATTENTION

If there is an opening/closing switch, it must be located in a protected position at a height of at least 1500 mm above ground level and in a safe place.

! ATTENTION

The awning must be installed at a minimum height of 2500 mm. If this is not possible, for awnings equipped with automations it is obligatory to install an acoustic warning device.

5.1 - Limit switch calibration

i INFORMATION AND PRECAUTIONS

Before installation, check that the limit switch is properly calibrated. If it requires adjustment, follow the instructions in the attached "Motor Manual".

5.2· Electrical connections and installation



ATTENTION

The electrical connections must be performed by qualified personnel and with the electrical energy disconnected.



INFORMATION AND PRECAUTIONS

It is prohibited to connect two or more motors to the same switch due to the risk of induced current which would result in damage to the motors.

Installation of the motorized awning is performed with the same procedure as the manual awning, except for the application of the crank rod (Chap. 4.2, "Box installation", point 3).

Instructions for electrical connection and programming the type of operation are described in the "Motor Manual" which is attached.

6 OPTIONALS

6.1· Automations

(Only for motorized awnings)

WIND GAUGE, RAIN GAUGE, TWILIGHT SENSOR: installation of these optional is described in the manuals for automations and for requested controls.



ATTENTION

For awnings with automations, the awning must be installed at a minimum height of 2500 mm. If this is not possible, it is obligatory to install an acoustic warning device.

7 SPECIAL MAINTENANCE

7.1 Troubleshooting table

MANUAL AWNING

PROBLEMS	CAUSES	SOLUTIONS
Conical rolling of canvas	Incorrect symmetry of arms	See manual for Assembly, Chap. 7
	Uneven fabric thickness	Roll the canvass all the way back up

MOTORIZED AWNING

Without electronic control unit

PROBLEMS	CAUSES	SOLUTIONS
Conical rolling of canvas	Incorrect symmetry of arms	See manual for Assembly, Chap. 7
	Uneven fabric thickness	Roll the canvass all the way back up
The awning does not roll up all the way.	Incorrect adjustment of limit switch	See manual for motor (attached)
The awning does not open up all the way.	Movement of motor crown during operation	See manual for Assembly, Chap. 8
The motor is very noisy	Incorrect wiring	See manual for motor (attached)
	Motor defective	See manual for motor (attached)
The motor shuts down after 4-5 minutes of continuous operation	Thermal protection of motor trips	Let the motor cool off for a few minutes

With electronic control unit

PROBLEMS	CAUSES	SOLUTIONS
The awning does not move	Fuse blown	Replace the fuse as shown in the attached manual
	Incorrect wiring	See manual for motor (attached)
The awning moves in jerks (moves for 50 cm, stops, etc.)	Faulty wind gauge	See instructions on automations (attached)
The awning does not roll up in high winds.	Fuse blown	Replace the fuse as shown in the attached manual
	Faulty wind gauge	See instructions on automations (attached)
The awning does not roll up in heavy rain.	Fuse blown	Replace the fuse as shown in the attached manual
	Rain gauge defective	See instructions on automations (attached)
With radio remote control, the awning opens or closes by itself.	Battery dead	Replace battery in radio remote control (see instructions concerning controls)



BAT S.p.A.
Via H.Ford, Z.I. Est
30020 Noventa di Piave (VE) Italy
tel +39 042165672
fax +3900421659007
info@batgroup.com
www.batgroup.com